

# Study of non-stationary Heat conduction in a Plane Plate for Symmetric and Asymmetric Problem

HANA CHARVÁTOVÁ, DAGMAR JANÁČOVÁ, KAREL KOLOMAZNÍK

Tomas Bata University in Zlín

Faculty of Applied Informatics

nám. T. G. Masaryka 5555, 760 01 Zlín

CZECH REPUBLIC

charvatova@fai.utb.cz <http://www.fai.utb.cz>

*Abstract:* In the paper we deal with study of the problems of non-stationary heat conduction in a plane plate. In the first part of paper we formulate mathematic model for the cases of symmetric and asymmetric heating or cooling of a solid plate. In the second part we compute various cases of temperature fields in the plate during the mentioned process by mathematic software Maple. Finally we present formulated mathematic models using for optimization of two real technological operations of natural and synthetic polymers processing – modelling of moulding of plastic material and modeling of temperature field in wall of tanning drum by enzymatic hydrolysis.

*Key-Words:* Modeling, Non-stationary Heat Conduction, Plastic Moulding, Tanning Process

## 1 Introduction

Heat conduction in a wall of the solid body, caused by heat action of a surrounding body, is a part of many technological operations during which the processed material is heated or cooled. This phenomena occurs by treatment of metals, plastics, rubbers etc. Course of the process always depends on geometry of the solid body and on other specific conditions [1],[2].

In the paper we focused on one of the most frequent case of non-stationary heat conduction in a solid material. It is unsteady heat conduction in a solid body which is caused by double-sided heating or cooling of the surrounding environment [5], [6].

Experimental determination of the process course is very difficult; nevertheless this information is necessary for suggestion of its optimal technological procedure [1], [3], [4], [6], [7]. Therefore we formulated mathematic model based on physical patterns of given process and verified its validity. Next we used analytical solution of the model for assessment of a concrete case of natural and synthetic polymers processing as shown in following text.

## 2 Problem formulation

In this section we will solve the problem of unsteady symmetric and asymmetric heat conduction in a plane plate made from isotropic material. Length and width of the plate are much longer than its thickness  $\delta$ .

### 2.1 Symmetric temperature field

The plate of initial temperature  $t_p$  is suddenly exposed double-sided heat action of ambient temperature  $t_o$ . The ambient temperature doesn't depend on time. Geometry sketch of the mentioned problem is in Fig. 1.

We used Fourier-Kirchhoff equation of heat conduction (1) with initial and boundary conditions (2) – (4) for modeling of the problem [6], [8].

$$\frac{\partial t(x, \tau)}{\partial \tau} = a \frac{\partial^2 t}{\partial x^2}(x, \tau) \quad 0 < x < b; \tau > 0 \quad (1)$$

$$-\lambda \frac{\partial t}{\partial x}(b, \tau) = \alpha(t - t_o) \quad (2)$$

$$t(x, 0) = t_p \quad (3)$$

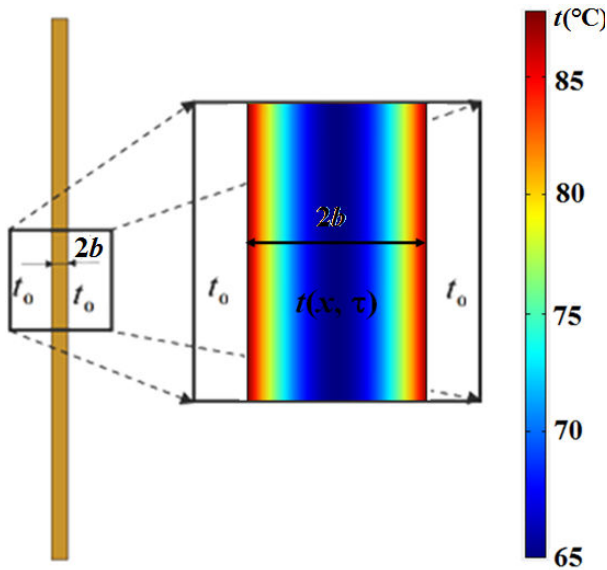
$$t(x, \tau \rightarrow \infty) = t_o \quad (4)$$

$$t(b, \tau) = t_o \quad (5)$$

$$\frac{\partial t(0, \tau)}{\partial x} = 0 \quad (6)$$

Equation (1) describes a non-stationary temperature field in the plate. Heat balance equation (2) represents heat transfer between plane and surrounding fluid (2). Equation (3) is initial conditions. Equations (4) and (5) represent

boundary conditions. Equation (6) is condition of symmetry.



**Fig. 1** Geometry sketch of the non-stationary symmetric heat conduction in a plane plate

By use of Laplace transformation we obtained analytical solution of the formulated model. Temperature field in a wall during heating (cooling)  $t(x, \tau)$  is given by equation (7):

$$t(x, \tau) = \left( (t_p - t_0) 2 \sum_{n=1}^{\infty} \frac{\sin(q_n)}{q_n + \sin(q_n)\cos(q_n)} \cos\left(\frac{x}{b}q_n\right) e^{-\frac{a\tau}{b^2}q_n^2} \right) + t_0 \tag{7}$$

where  $a$  is thermal diffusivity of the heated (cooled) body

$$a = \frac{\lambda}{\rho \cdot c_p} \tag{8}$$

$q_n$  are roots of the following equation

$$\cot(q) = \frac{\lambda}{\alpha b} q \tag{9}$$

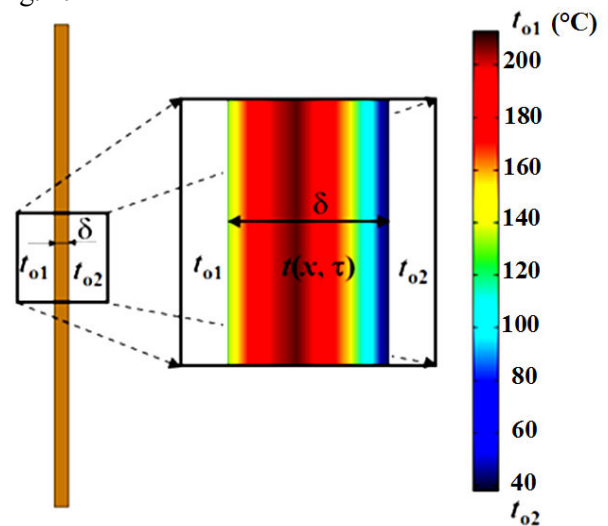
where:

- $a$  - thermal diffusivity of the heated (cooled) material,  $[m^2 \cdot s^{-1}]$
- $c_p$  - specific thermal capacity of the heated (cooled) body,  $[J \cdot kg^{-1} \cdot K^{-1}]$
- $t$  - temperature of the heated (cooled) body,  $[^{\circ}C]$
- $t_o$  - ambient temperature  $[^{\circ}C]$
- $t_p$  - initial temperature of the heated (cooled) body,  $[^{\circ}C]$

- $x$  - space coordinate, m;
- $\alpha$  - heat transfer coefficient,  $[W \cdot m^{-2} \cdot K^{-1}]$
- $\delta$  - thickness of the heated (cooled) body, [m]
- $\lambda$  - thermal conductivity of the heated (cooled) body,  $[W \cdot m^{-1} \cdot K^{-1}]$

### 2.2 Asymmetric temperature field

In this case, the plate of initial temperature  $t_p$  is suddenly exposed double-sided heat action of surrounding environment, whereas we supposed that temperature of surrounding environment on the left side from plate  $t_{o1}$  is different to temperature on the right side from plate  $t_{o2}$ . Temperatures of both environments don't depend on time and in addition they differ from initial temperature of the plate [6]. Geometry sketch of the mentioned problem is in Fig. 2.



**Fig. 2** Geometry sketch of the non-stationary asymmetric heat conduction in a plane plate

With respect to above mentioned assumptions, the heat transfer across the wall will be asymmetric in accordance with axis of the wall. We used Fourier-Kirchhoff equation of heat conduction (10) with initial and boundary conditions (11) – (13) for modeling of the problem.

$$\frac{\partial t(x, \tau)}{\partial \tau} = a \frac{\partial^2 t(x, \tau)}{\partial x^2} \tag{10}$$

$$t(x, 0) = t_p \tag{11}$$

$$t(0, \tau) = t_{o1} \tag{12}$$

$$t(\delta, \tau) = t_{o2} \tag{13}$$

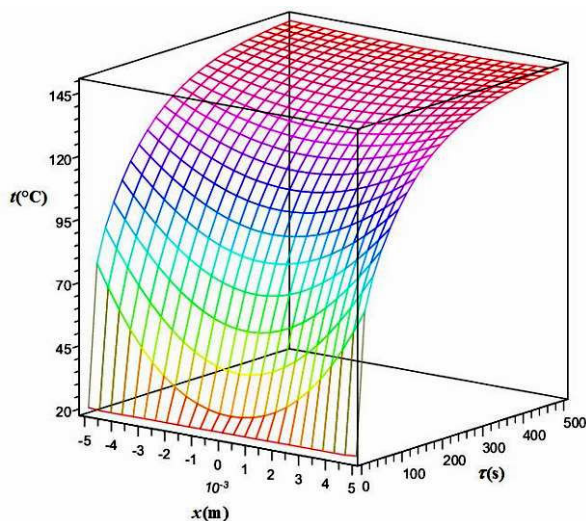
Equation (11) is assumption of the initial uniform temperature distribution in a heated or cooled body. Conditions (12) and (13) assume that temperature of a wall margin is constant and it equals surrounding temperature.

By use of Laplace transformation we obtained analytical solution of the formulated model. Temperature field in a wall during heating (cooling)  $t(x, \tau)$  is given by equation (14):

$$\begin{aligned}
 t(x, \tau) = & t_p + \frac{(x - \delta)(t_p - t_{o1})}{\delta} + \\
 & + 2 \sum_{n=1}^{\infty} \frac{(-1)^{n+1}}{n \cdot \pi} \sin\left(\frac{(\delta - x)}{\delta} n \cdot \pi\right) e^{-\left(\frac{(n \cdot \pi)^2 a \cdot \tau}{\delta^2}\right)} (t_p - t_{o1}) + \\
 & + \frac{x(t_{o2} - t_p)}{\delta} + \\
 & + 2 \sum_{n=1}^{\infty} \frac{(-1)^{n+1}}{n \cdot \pi} \sin\left(-\frac{x}{\delta} \cdot n \cdot \pi\right) e^{-\left(\frac{(n \cdot \pi)^2 a \cdot \tau}{\delta^2}\right)} (t_{o2} - t_p)
 \end{aligned}
 \tag{14}$$

In the case that temperature of left surrounding is the same as initial temperature of plane plate (i.e.  $t_{o1} = t_p \neq t_{o2}$ ), the analytical solution is

$$\begin{aligned}
 t(x, \tau) = & t_p + \frac{x(t_{o2} - t_p)}{\delta} + \\
 & + 2 \sum_{n=1}^{\infty} \frac{(-1)^{n+1}}{n \cdot \pi} \sin\left(-\frac{x}{\delta} \cdot n \cdot \pi\right) e^{-\left(\frac{(n \cdot \pi)^2 a \cdot \tau}{\delta^2}\right)} (t_{o2} - t_p)
 \end{aligned}
 \tag{15}$$



**Fig. 3** Temperature field in a plate during symmetric heating. Parameters:  $t_p = 20 \text{ }^\circ\text{C}$ ,  $t_o = 150 \text{ }^\circ\text{C}$ ,  $a = 9,6 \cdot 10^{-7} \text{ m}^2\text{s}^{-1}$

Analogously, for  $t_{o2} = t_p \neq t_{o1}$  we obtained solution

$$\begin{aligned}
 t(x, \tau) = & t_p + \frac{(x - \delta)(t_p - t_{o1})}{\delta} + \\
 & + 2 \sum_{n=1}^{\infty} \frac{(-1)^{n+1}}{n \cdot \pi} \sin\left(\frac{(\delta - x)}{\delta} n \cdot \pi\right) e^{-\left(\frac{(n \cdot \pi)^2 a \cdot \tau}{\delta^2}\right)} (t_p - t_{o1})
 \end{aligned}
 \tag{16}$$

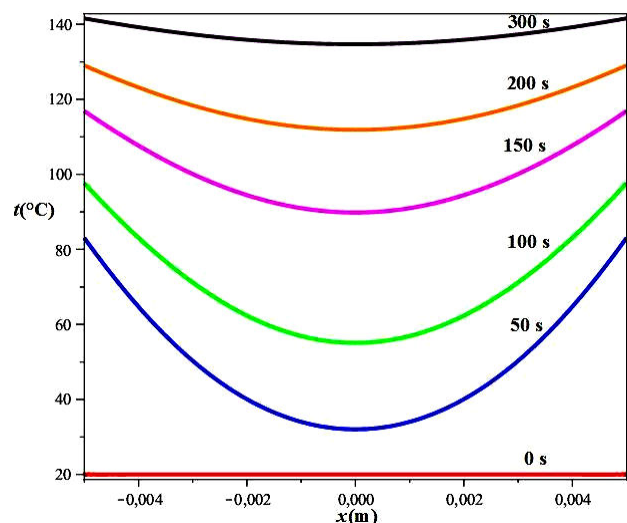
where  $n = 1, 2, \dots, \infty$ . Symbol  $\pi$  is the circular constant. Symbol  $\delta$  is thickness of the plate. Meaning of other symbols is the same as in previous model of symmetric temperature field.

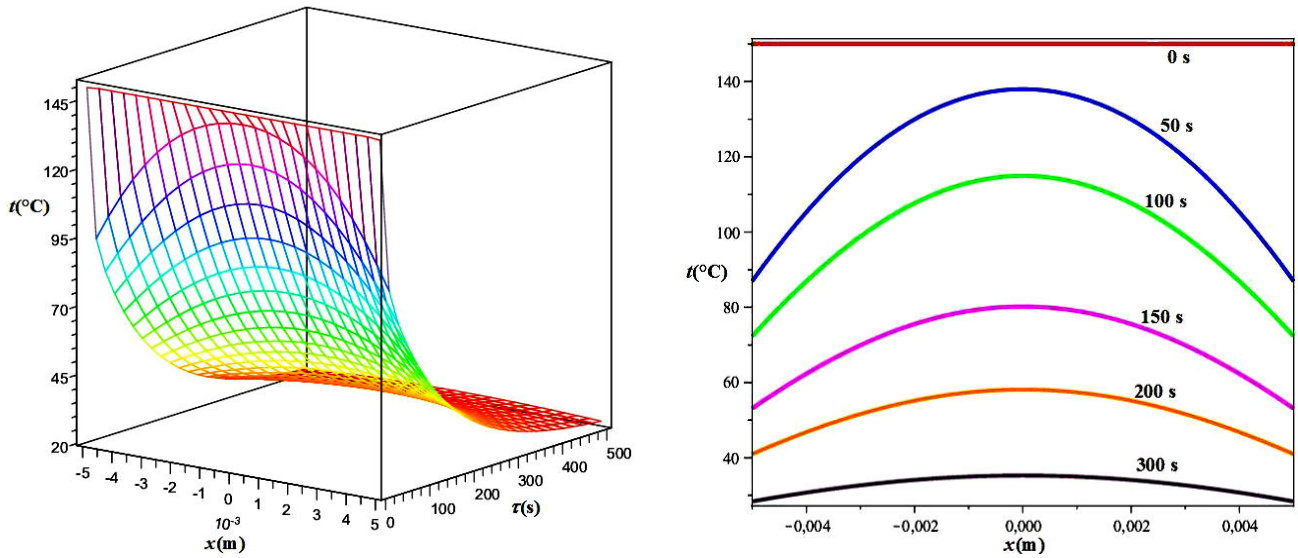
### 3 Modeling of the temperature field

We used mathematic software Maple for description of the heat conduction in a solid plate. In Maple user environment we solved and visualized the non-stationary temperature fields in a solid plate by its heating and cooling [9].

#### 3.1 Symmetric temperature field

In Fig. 3 and Fig.4 we show courses of symmetric heating and cooling by accordance with relation (7).





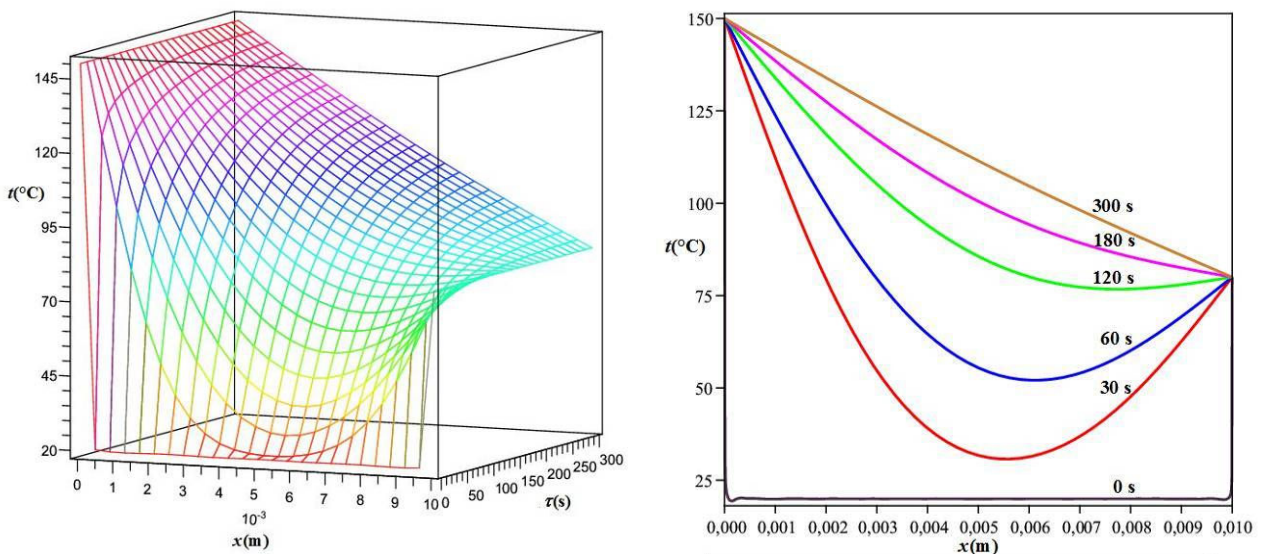
**Fig. 4** Temperature field in a plate during symmetric cooling. *Parameters:*  $t_p = 150^\circ\text{C}$ ,  $t_o = 20^\circ\text{C}$ ,  $a = 9,6 \cdot 10^{-7} \text{ m}^2\text{s}^{-1}$

### 3.1 Asymmetric temperature field

In the Fig. 5 – 7 we show common cases of the temperature fields in a plane plate which can occur by asymmetric temperature action of the surrounding environments that we computed according to equation (14). In these cases, the initial temperature of the plate differs to the temperatures of both surrounding environments of the plate, i.e.  $t_{o1} \neq t_p \neq t_{o2}$ . The Fig. 5 represents asymmetric heating under the condition  $t_{o1} > t_{o2} > t_p$ .

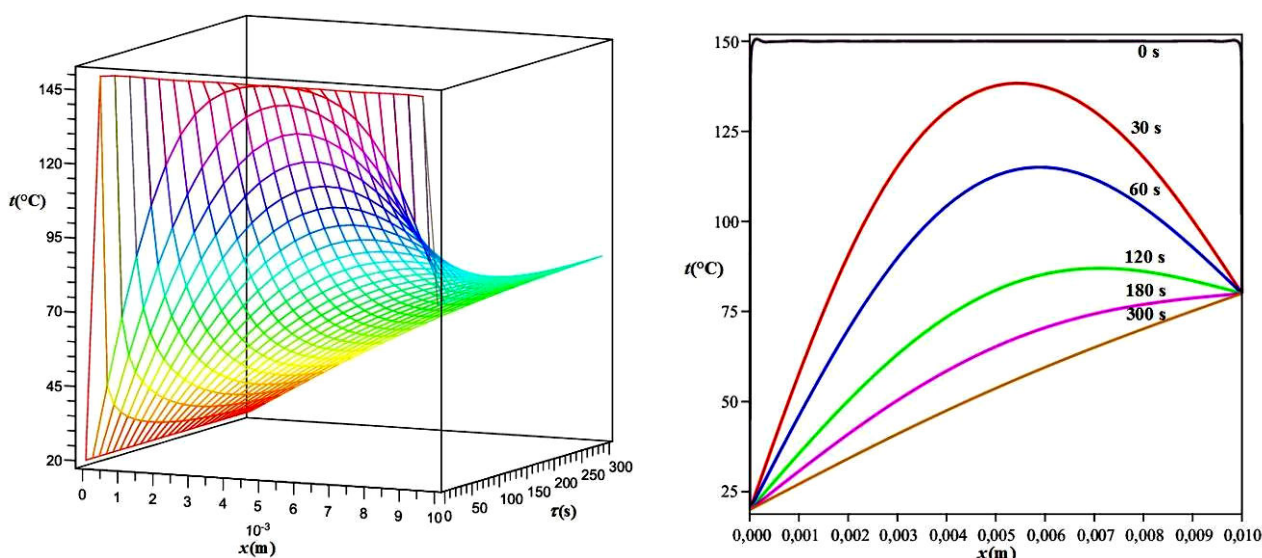
In the Fig. 6 you can see asymmetric cooling of the plate under the condition  $t_p > t_{o2} > t_{o1}$ .

The fig. 7 represents process of simultaneous heating and cooling. In this case the plate is cooled from the left side and heated from the right side, i.e.  $t_{o2} > t_p > t_{o1}$ .

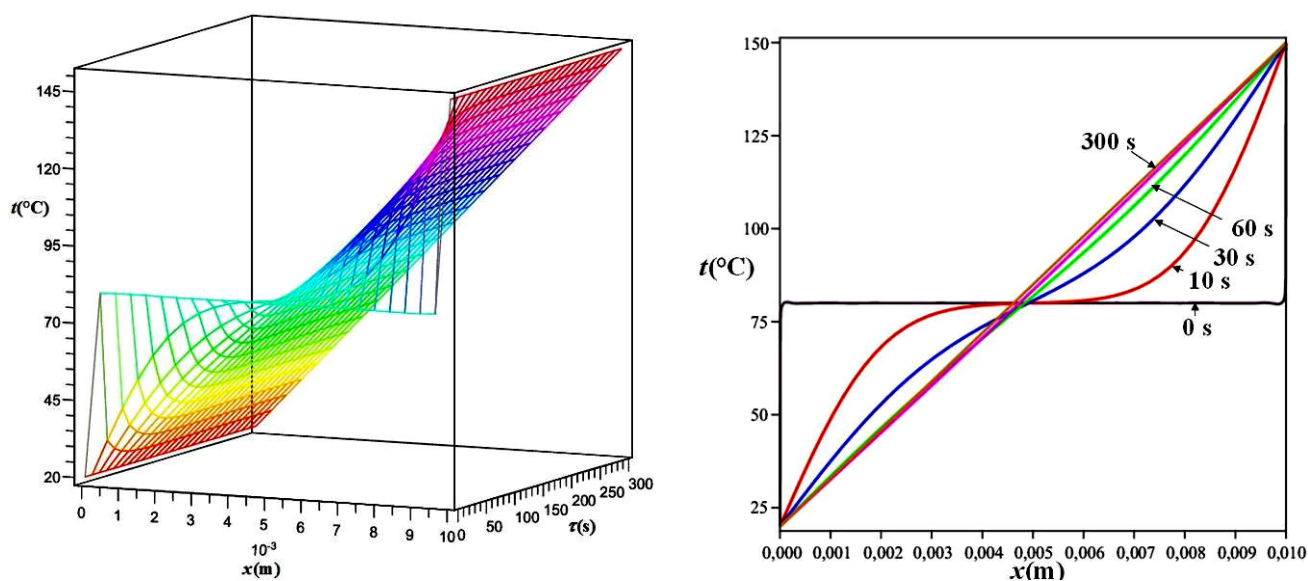


**Fig. 5** Temperature field in a plate during asymmetric heating. *Parameters:*  $t_p = 20^\circ\text{C}$ ,  $t_{o1} = 150^\circ\text{C}$ ,  $t_{o2} = 120^\circ\text{C}$ ,  $a = 9,6 \cdot 10^{-7} \text{ m}^2\text{s}^{-1}$





**Fig. 6** 3D and 2D Temperature field in a plate during asymmetric cooling.  
 Parameters:  $t_p = 150\text{ }^\circ\text{C}$ ,  $t_{o1} = 20\text{ }^\circ\text{C}$ ,  $t_{o2} = 80\text{ }^\circ\text{C}$ ,  $a = 9,6 \cdot 10^{-7}\text{ m}^2\text{s}^{-1}$

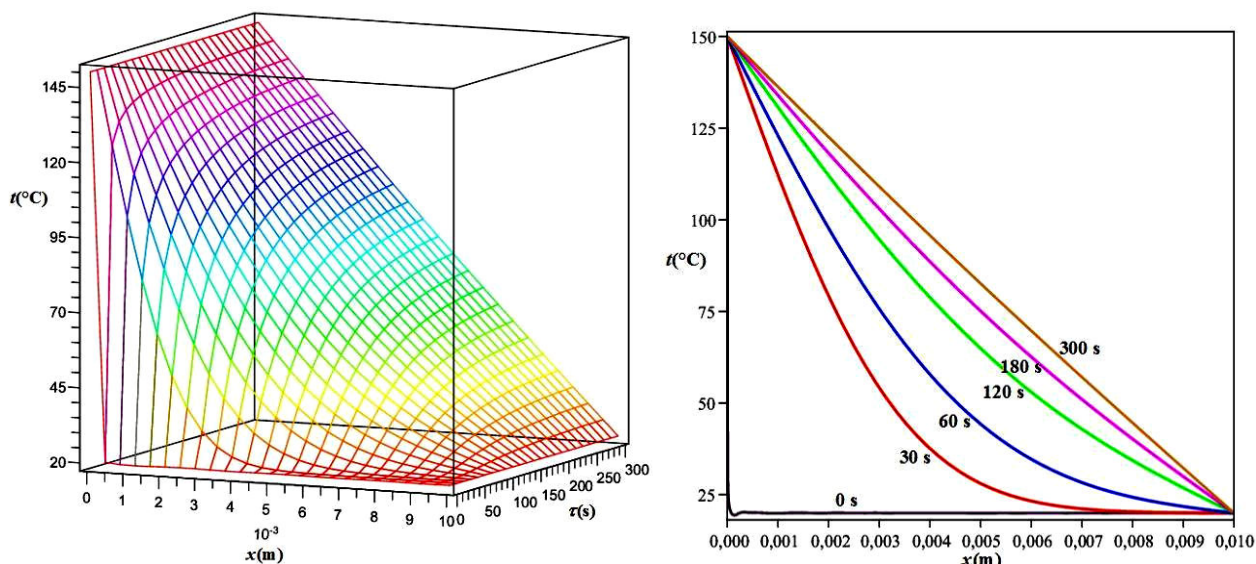


**Fig. 7** Temperature field in a plate during its simultaneous heating and cooling.  
 Parameters:  $t_p = 80\text{ }^\circ\text{C}$ ,  $t_{o1} = 20\text{ }^\circ\text{C}$ ,  $t_{o2} = 150\text{ }^\circ\text{C}$ ,  $a = 9,6 \cdot 10^{-7}\text{ m}^2\text{s}^{-1}$

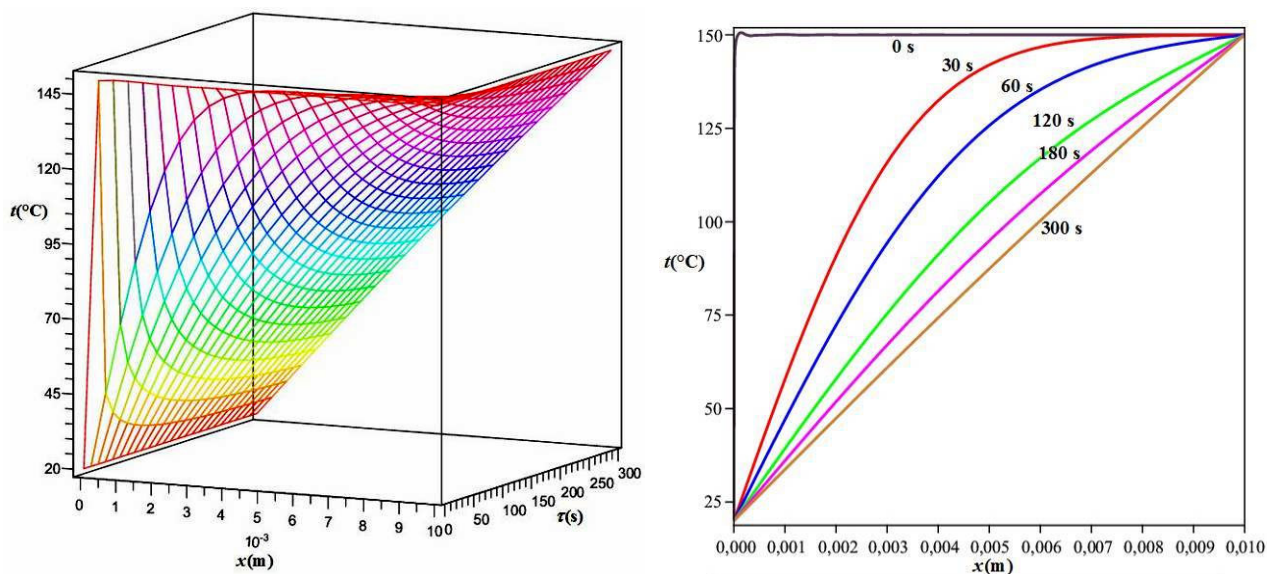
In the following Fig. 8 and Fig. 9 are special cases of the asymmetric temperature fields when temperature of one of the surrounding environments is the same as initial temperature of the plate.

The Fig. 8 represents temperature field by asymmetric heating when  $t_{o2} = t_p < t_{o1}$  that we

computed according to relation (16). The Fig. 9 represents asymmetric cooling under the condition  $t_{o1} = t_p \neq t_{o2}$ . We computed this temperature field form relation (15).



**Fig. 8** Temperature field in a plate during its heating *Parameters:  $t_p = 20\text{ }^\circ\text{C}$ ,  $t_{o1} = 150\text{ }^\circ\text{C}$ ,  $t_{o2} = 20\text{ }^\circ\text{C}$ ,  $a = 9,6 \cdot 10^{-7}\text{ m}^2\text{s}^{-1}$*



**Fig. 9** Temperature field in a plate during its cooling. *Parameters:  $t_p = 150\text{ }^\circ\text{C}$ ,  $t_{o1} = 20\text{ }^\circ\text{C}$ ,  $t_{o2} = 150\text{ }^\circ\text{C}$ ,  $a = 9,6 \cdot 10^{-7}\text{ m}^2\text{s}^{-1}$*

## 4 Experimental part

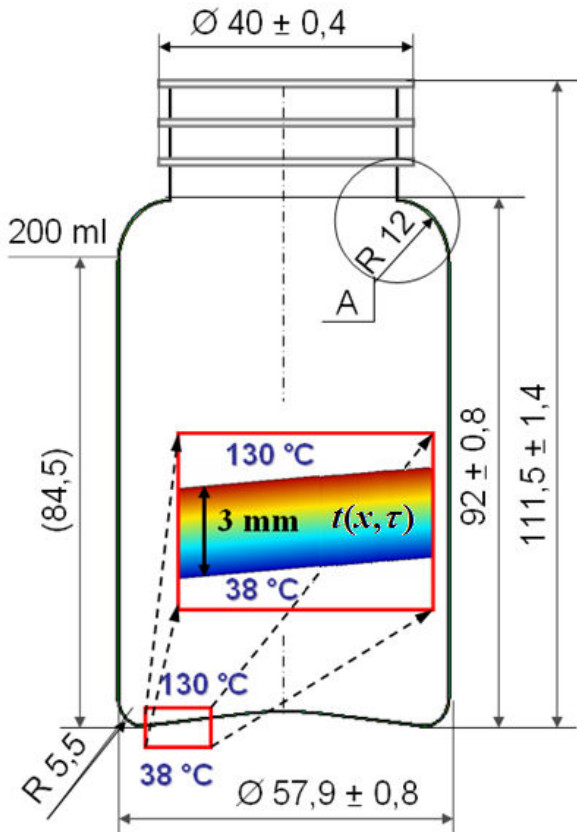
We applied the formulated models of heat conduction for assesment of the course of real technological operations of natural and synthetic processing - moulding of plastic material and modeling of temperature field in wall of a tanning drum during enzymatic hydrolysis by leather waste treatment. The obtained results we show in the following text.

### 4.1 Modelling of moulding of plastic material

In this example we describe process of blow moulding during moulding of button of plastic small bottles by their manufacturing . We applied the formulated model of asymmetric heat conduction for assesment of the course of real technological operation - injection moulding combined with subsequent blow moulding during moulding of

button of plastic small bottles by their manufacturing (Fig. 10).

In practice, first the oven-ready food for blowing will be prepared. After them, the form will be slightly open, the shape will be stuck up by jaws and blow moulding will follow. Time of the submitted cycle took 40 seconds. Expected time in practice manufacturing takes 40 seconds. For this purpose, we verified if it is possible to dissipate needed heat quantity in 20 seconds.



**Fig. 10** Scheme of the tested polypropylene bottle

We solved temperature under the conditions:

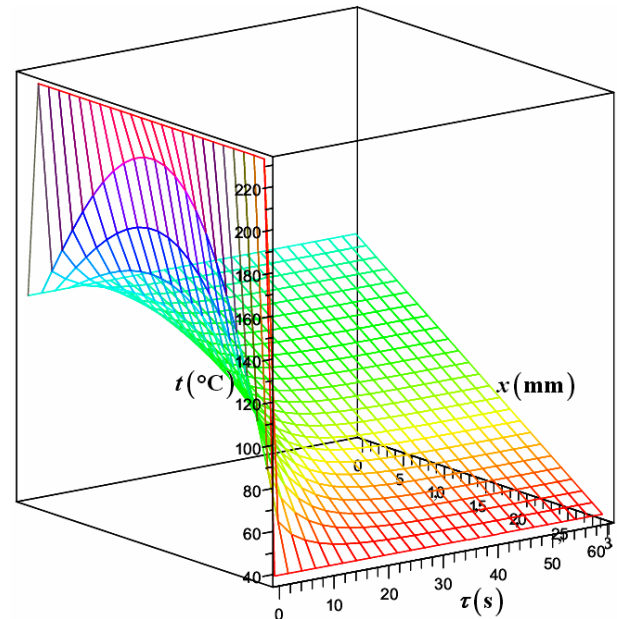
Temperature of force:	130 °C
Temperature of form:	38 °C
Temperature of melt:	230 °C
Thickness of bottom:	3 mm

Properties of polypropylene:

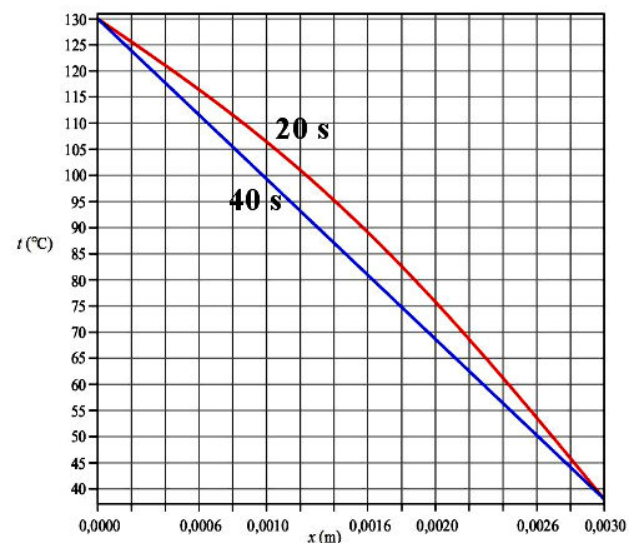
Density:	910 kg.m <sup>-3</sup>
Specific thermal capacity:	1700 J.kg <sup>-1</sup> .K <sup>-1</sup>
Thermal conductivity:	0.22 W.m <sup>-1</sup> .K <sup>-1</sup>

Temperature field in the bottom of bottle is shown in Fig. 11. The temperatures field in time

20 seconds and 40 seconds are shown in Fig. 12. It is evident that the cycle time 20 second is sufficient. In time 40 seconds, the process will be steady.



**Fig. 11** Temperature field in the bottom of polypropylene bottle during moulding process



**Fig. 12** Temperature field in the bottom of polypropylene bottle during moulding process in time 20 s and 40 s

#### 4.2 Modelling of temperature field in tanning drum during leather waste treatment by enzymatic hydrolysis

In this section we deal with recycling of chrome-tanned leather shavings that present a large quantity

of leather waste. From this point of view, the enzymatic hydrolysis represents ecologically acceptable process [10].

The main advantage of using proteolytic enzymes as the catalyst for the process of hydrolysis is that moderate reaction conditions can be employed. The reaction takes place at a temperature no higher than 80 °C, a pH value between 8 and 9, and under atmospheric pressure [11].

The practice realization of the process requires minimal operating costs. One possibility in reducing prices of protein hydrolysates consists in reducing investment costs. The chief problem consist in holding the temperatures of reaction mixture within such limits as to arrive at a comparable yield of soluble protein after the practically same time as when an isothermal reactor was used. A further effort of ours aimed at the tanning drum not having to be constructionally adapted. In theory, our tanning drum represents a non isothermal and non adiabatic reactor.

The temperature of drum wall in dependence on time may be calculated by resolving a mathematical model representing the hydrolytic reaction. In an effort at reaching a fast solution we set up a determinist model in accordance with simplified conditions as follow:

- The reaction mixture is intimately stirred by motion of drum.
- Heat transfer is perfect on both sides of drum wall.
- Reaction heat of hydrolysis is negligible.
- Drum has the shape of a cylinder, its radius being at least 10 times greater than thickness of wall so that the temperature field in wall may be described by an "infinite plate" model.
- Dependence of all physical parameters of the model on temperature is negligible.

Assuming these, we applied the following mathematical model [10], [11]:

$$\frac{\partial t(x, \tau)}{\partial \tau} = a \frac{\partial^2 t}{\partial x^2}(x, \tau) \quad (17)$$

$$0 < x < b; \tau > 0$$

$$m_0 c_0 \frac{\partial t_0(\tau)}{\partial \tau} = S \lambda \frac{\partial t}{\partial x}(0, \tau) \quad (18)$$

$$t(x, 0) = t_p \quad (19)$$

$$t(b, \tau) = t_p \quad (20)$$

$$t(0, \tau) = t_0 \quad (21)$$

$$t_0(0) = t_{op} \quad (22)$$

Equation (17) describes a non-stationary temperature field in the wall of drum. Heat balance expressing equilibrium between rate of decrease in reaction mixture temperature and transfer of heat through reactor wall is described by equation (18). Equations (19) and (20) are initial conditions, and equations (21) and (22) describe conditions of perfect heat transfer. We used Laplace transformation for analytical solution of the given model. The temperature field in drum wall  $t(x, \tau)$  is given by relation:

$$\frac{t - t_p}{t_{op} - t_p} = 2 \sum_{n=1}^{\infty} \frac{\cos(q_n) \sin \left[ \left(1 - \frac{x}{b}\right) q_n \right]}{q_n + \sin(q_n) \cos(q_n)} e^{-\frac{a\tau}{b^2} q_n^2} \quad (23)$$

where  $q_n$  are roots of the following equation,

$$\cot(q) = q \cdot Ja \quad (24)$$

and  $Ja$  is a dimensionless number expressing . It is the ratio of reaction mixture enthalpy and enthalpy of drum wall.

$$Ja = \frac{m_0 c_0 \Delta t_0}{m c \Delta t} \quad (25)$$

#### List of used symbols

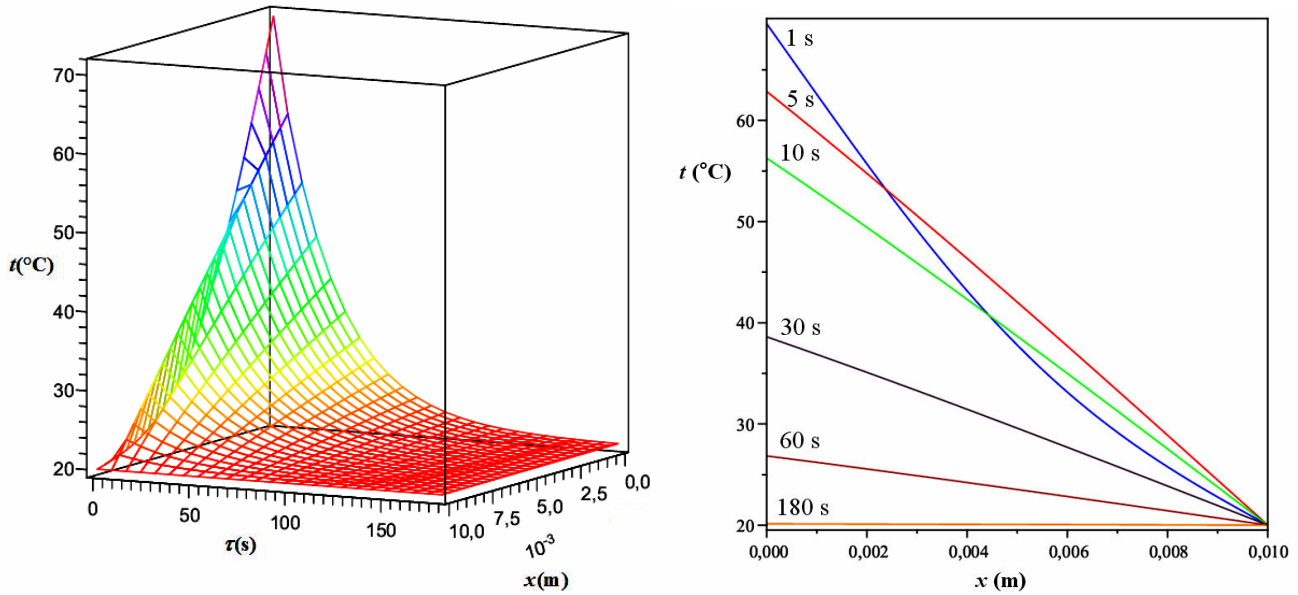
- $t$  - temperature of drum wall, [ °C ]  
 $t_0$  - temperature of reaction mixture, [ °C ]  
 $t_p$  - initial temperature of drum wall, [ °C ]  
 $t_{op}$  - initial temperature of drum charge, [ °C ]  
 $\tau$  - time, [ s ]  
 $x$  - coordinate of drum wall, [ m ]  
 $b$  - thickness of drum wall, [ m ]  
 $m_0$  - mass of reaction mixture in drum, [ kg ]  
 $c_0$  - specific thermal capacity of reaction mixture, [ J kg<sup>-1</sup> K<sup>-1</sup> ]  
 $c$  - specific thermal capacity of drum walls, [ J kg<sup>-1</sup> .K<sup>-1</sup> ]  
 $S$  - total area of drum inner walls (exchange area), [ m<sup>2</sup> ]  
 $\lambda$  - thermal conductivity of drum wall, [ W.m<sup>-1</sup>.K<sup>-1</sup> ],  
 $m$  - mass of drum wall, [ kg ].



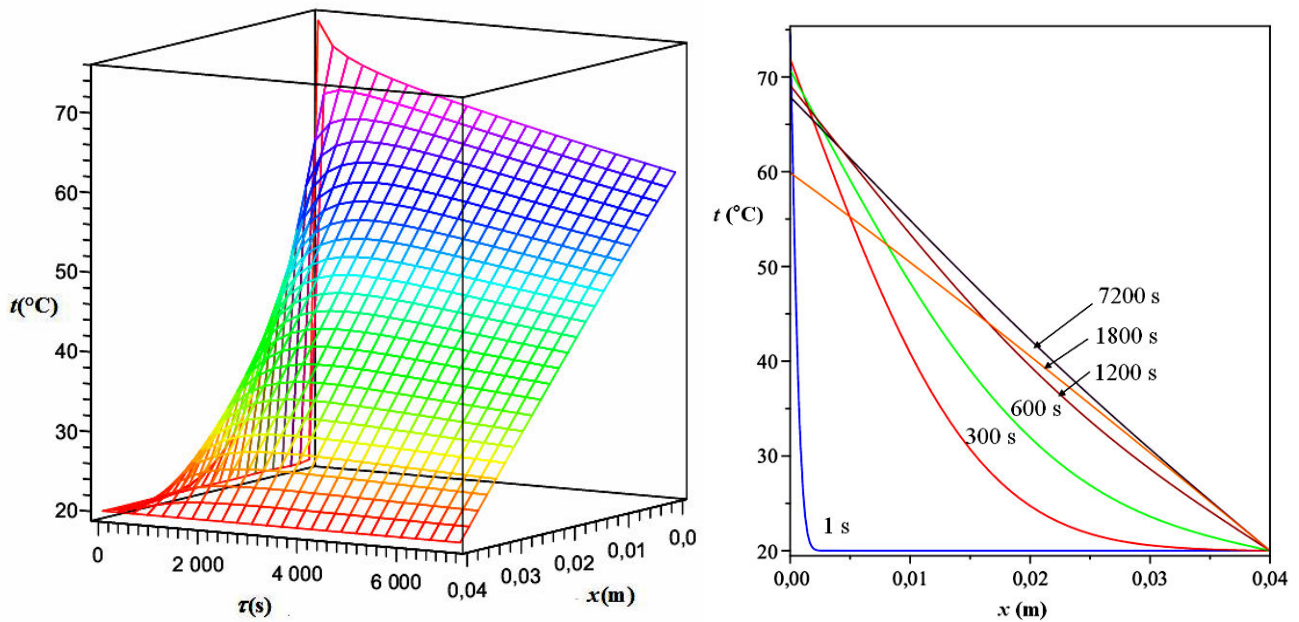
The temperature diffusivity is major parameter that influences temperature distribution in the drum wall and in the reaction mixture.

From this point of view, we compared temperature distribution in a wall of drum made

form steel and in a wall of drum made from wood (Fig. 13 and Fig. 14).



**Fig. 13** The non-stationary temperature field in steel drum wall  
 Parameters:  $t_{op} = 75 \text{ }^\circ\text{C}$ ,  $t_p = 20 \text{ }^\circ\text{C}$ ,  $b = 1 \text{ cm}$ ,  $a = 1,45 \cdot 10^{-5} \text{ m}^2\text{s}^{-1}$ ,  $Ja = 4$



**Fig. 14** The non-stationary temperature field in wood drum wall  
 Parameters:  $t_{op} = 75 \text{ }^\circ\text{C}$ ,  $t_p = 20 \text{ }^\circ\text{C}$ ,  $b = 4 \text{ cm}$ ,  $a = 2,3 \cdot 10^{-7} \text{ m}^2\text{s}^{-1}$ ,  $Ja = 4$

## 5 Conclusion

The obtained results proved that the formulated mathematic models of temperature fields are suitable for description asymmetric and heat conduction in a plane plate.

The computed data were in both described examples of real technological operations (moulding of plastic material and temperature field in the wall of tanning drum during enzymatic hydrolysis by leather waste treatment) in accordance with experimentally measured data. Therefore our mathematical models can be used for description and optimization of the studied processes.

Therefore, the models can be used for examination of any process of non-stationary heating or cooling of a solid plane which are based on the same mechanism as we solved in this paper.

### References:

- [1] K. Kolomazník, et al., Mathematical simulation for optimization of tanning processes; delimiting of white hide. In *Proceedings of the 8th WSEAS International Conference on Applied Informatics and Communications*, Rhodes, Greece, 2008, p. 174.
- [2] L. Sýkorová, O. Šuba, M. Malachová, J. Černý, "Temperature Field Simulation of Polymeric Materials During Laser Machining Using COSMOS / M Software", in *13th WSEAS International Conference on Automatic control, modelling & simulation (ACMOS'11)*, WSEAS Press, Lanzarote, Canary Islands, 2011.
- [3] O. Šuba, L. Sýkorová, Š. Šanda, M. Staněk, "Modelling of Thermal Stresses in Printed Circuit Boards", in *13th WSEAS International Conference on Automatic control, modelling & simulation (ACMOS'11)*, WSEAS Press, Lanzarote, Canary Islands 2011.
- [4] L. Vašek, V. Dolinay, „Simulation Model of Heat Distribution and Consumption in Municipal Heating Network”, in *14th WSEAS International Conference on Systems. Latest Trends on Systems. Volume II*, WSEAS Press (GR), Rhodes, 2010, p.439-442.
- [5] A. V. Lykov, *Teoria teploprovodnosti*. Vysšaja škola, Moskva, 1967.
- [6] K. Kolomazník, *Modeling of Manufacturing Processes*, 1st Ed. VUT Brno, Faculty of Technology in Zlín, 1990, p. 72. (in Czech)
- [7] P. Dostálek, V. Vašek, J. Dolinay, Portable Data Acquisition Unit for Process Control and Monitoring Applications. *8th WSEAS International Conference on Applied Informatics and Communications*, Rhodes, Greece, 2008, p. 120.
- [8] H. S. Carslaw & J. C. Jaeger, *Conduction of Heat in Solids*. 2<sup>nd</sup> Ed. Oxford University Press, New York, 2008.
- [9] Ch. Tocci, & S. Adams, *Applied Maple for Engineers and Scientists*. Artech House Publishers, Boston, 1996.
- [10] K. Kolomazník K, V. Vašek, D. Janáčová, Control Recycling Technology of Tannery Chromium Wastes. In *Proceedings of the 13th WSEAS International Conference on computers*, Rhodes, Greece, 2009, p. 550.
- [11] J. Dolinay, et al., New Embedded Control System for Enzymatic Hydrolysis. In *Proceedings of the 8th WSEAS International Conference on Applied Informatics and Communications*, Rhodes, Greece, 2008, p. 174.
- [12] O. Kirk, *Encyclopedia of Chemical Technology*, 4th. Ed., Vol. 6, p. 269, N.Y. Wiley, 1992.
- [13] A. J. Dean, *Lange's Handbook of Chemistry*, 14th. Ed., Mc. Graw-Hill, INC, N.Y. 1992.
- [14] R. H. Perry & D. W. Green, *Perry's chemical engineers' handbook*. 7th Ed. McGraw-Hill Book Co., New York, 1999, CD ROM.
- [15] H. Charvátová, D. Janáčová, K. Kolomazník, Z.Dvořák, *Thermophysical properties of the selected substances*, Tomas Bata University in Zlín, Faculty of Applied Informatics, Zlín, 2009.
- [16] Ch. Tocci, S. Adams, *Applied Maple for Engineers and Scientists*. Boston: Artech House Publishers, 1996. ISBN 0890068534
- [17] S. Lynch, *Dynamical Systems with Applications using Maple*, Boston: Birkhäuser, 2000.
- [18] Martha L. Abell, James B. Braselton, *Maple by Example*, Burlington: Elsevier Academic Press. 2005.

*Acknowledgement:* This work was supported by the Ministry of Education, Youth and Sports of the Czech Republic under the Research Plan No. MSM 7088352102 and by the European Regional Development Fund under the project CEBIA-Tech No. CZ.1.05/2.1.00/03.0089.